

FGJ(DIN-ANSI-JIS)
 PN25(DN32)
 /mm/

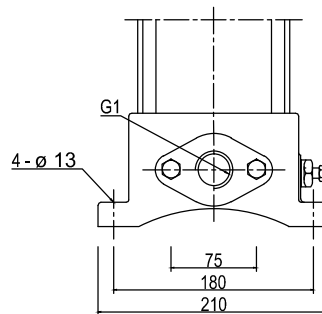

CVE 2-15

PUMPS	07.07.2020
Textilná 3/A	
040 12 Košice	

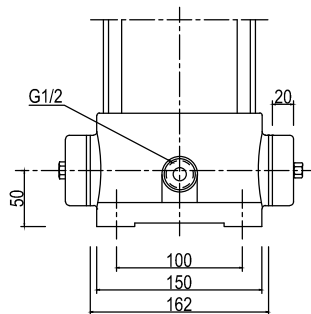
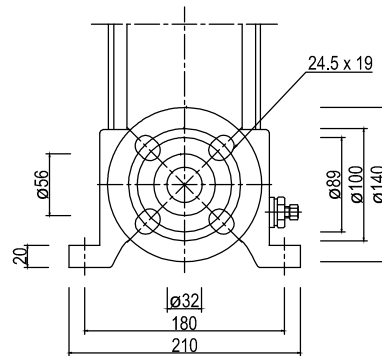