

FGJ(DIN-ANSI-JIS)
PN25(DN32)
/mm/

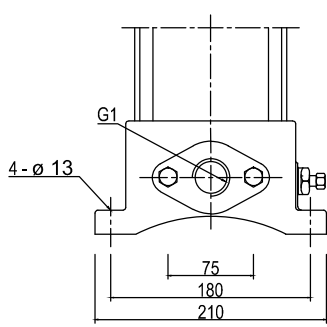
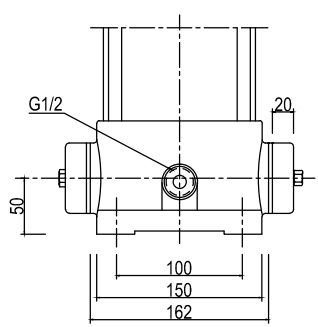
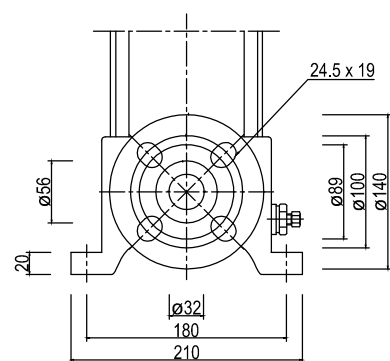

CVE 4-16		
PUMPS	07.07.2020	
Textilná 3/A		
040 12 Košice		