

FGJ(DIN-ANSI-JIS)  
 PN16-25-40(DN50)  
 /mm/

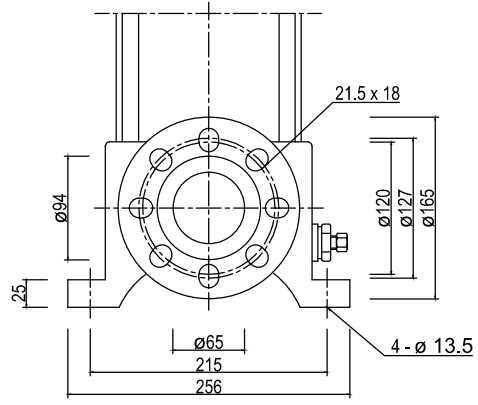

CVE 15-5		
PUMPS	07.07.2020	
Textilná 3/A		
040 12 Košice		