

FGJ(DIN-ANSI-JIS)
PN25(DN32)

/mm/

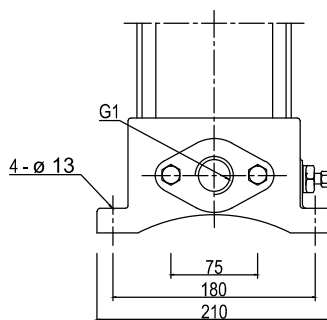
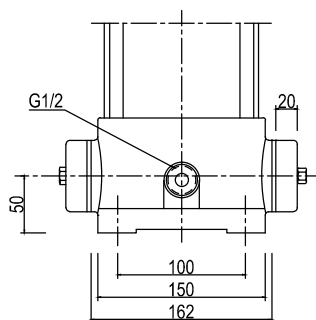
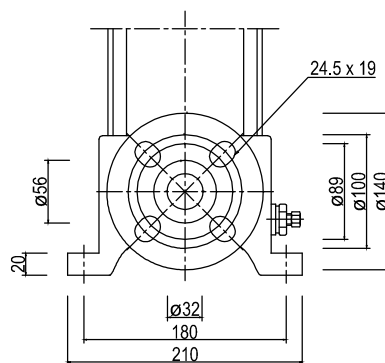

BV 1-7

| | |
|---------------|------------|
| PUMPS | 07.07.2020 |
| Textilná 3/A | |
| 040 12 Košice | |

